



COLOR TELEVISION

AV-21MT16

AV-29MT16

AV-21MT36

AV-29MT36

AV-25MT16

EQUALIZER • CINEMA SURROUND • COMPONENT INPUT

Contents

Knowing your TV's features	3
Remote control buttons and basic functions	4
TV buttons and functions.....	6
Setting up your TV.....	7
Basic setting for picture	9
Advanced setting for picture.....	11
Basic setting for sound.....	12
Advanced setting for sound.....	13
DVD function	14
Customized setting	15
TV channel presetting	17
Additional preparation	18
Troubleshooting.....	20
Specifications	21

INSTRUCTIONS

Thank you for buying this JVC color television.
To make sure you understand how to use your new TV, please read this manual thoroughly before you begin.

WARNING: TO PREVENT FIRE OR SHOCK HAZARD, DO NOT EXPOSE THIS APPLIANCE TO RAIN OR MOISTURE.

CAUTION: TO ENSURE PERSONAL SAFETY, OBSERVE THE FOLLOWING RULES REGARDING THE USE OF THIS TV.

- 1 Operate only from the power source indicated on the rear of the TV.
- 2 Avoid damaging the power cord and mains plug. When unplugging the TV, grasp the mains plug. Do not pull on the power cord.
- 3 Never block or cover the ventilation openings.
Never install the TV where good ventilation is unattainable.
When installing this TV, leave spaces for ventilation around the TV of more than the minimum distances as shown.

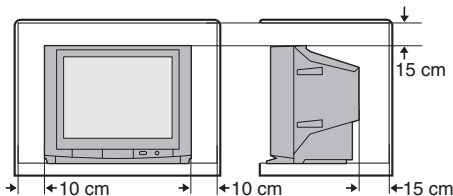

- 4 Do not allow objects or liquid into the cabinet openings.
- 5 In the event of a fault, unplug the unit and call a service technician. Do not attempt to repair it yourself or remove the rear cover.
- 6 The surface of the TV screen is easily damaged. Be very careful with it when handling the TV. Should the TV screen become soiled, wipe it with a soft dry cloth. Never rub it forcefully. Never use any cleaner or detergent on it.

- 7 This TV can be turned on / off power by connecting / disconnecting the AC Plug into AC outlet. While this TV is being installed, enough space should be reserved for connecting / disconnecting the AC Plug into AC outlet by hand.
- 8 The apparatus shall not be exposed to dripping or splashing and that no objects filled with liquids, such as vases, shall be placed on the apparatus.

WARNING: <AV-21M, AV-25M, AV-29M Series>

YOU CAN DETACH THE PROTECT SHEET ON THE TOP AND BOTTOM OF FRONT FRAME IF YOU NEEDED. THE FRONT BUTTON DOOR OF THE TV SHOULD BE PULLED OUT FROM ITS BOTTOM. DO NOT PRESS THE UPPER PART, OR YOUR FINGER MAY BE PINCHED.

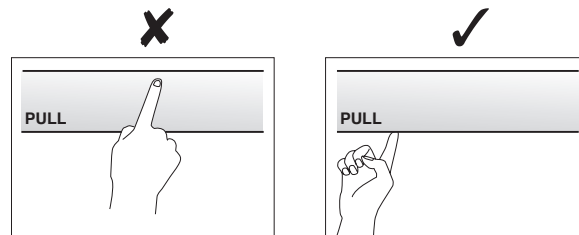

Knowing your TV's features

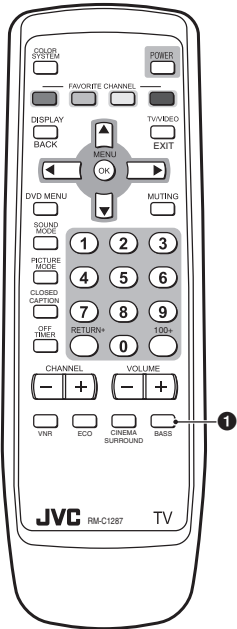

Main features

DVD MENU	Just connect DVD player to the television. The television will detect DVD signal and display picture on the screen automatically and you can adjust pictures and sound while you are watching DVD as your desire.
MTS	You can listen the stereo sound or SAP from TV program broadcasting by MTS system. (SAP: Second audio program.)
CLOSED CAPTION	You can display dialog on the screen from TV broadcasting with Closed caption system. You also may be able to display some information in text form if available.
FAVORITE CH (Channel)	You can register up to four favorite channels for quick recall with one press.
AI ECO	TV detects the brightness of your room and automatically adjust the picture brightness to a suitable level for a better eye care.
AI VOLUME	TV adjusts the volume automatically to the same level for all TV channels to avoid sudden change of the volume when selecting different TV channel or selecting Video mode.
VNR	You can reduce the picture noise when viewing noisy TV programs or video sources.

Confirm your TV's functions

Some functions written in this instruction manual may not be available for your TV.

Please see the chart below and check the functions that are equipped for your TV's model number. The model number is indicated at the rear of your TV. When you press a button concerned to a function that is not available for your TV, it does not work and the logo "Ø" appears on the screen.

NO.	Model No.	AV-21MT16	AV-21MT36	AV-25MT16	AV-29MT16	AV-29MT36
	Function					
❶	SUPER BASS	—	Ø	—	—	Ø
—	PICTURE TILT	—	—	—	Ø	Ø

Remote control buttons and basic functions

No. Press	To
① POWER	Turn on or off the TV from standby mode.
② MENU/OK	Display menu and confirm selected function.
③ ▲ / ▼ / ◀ / ▶	Select and adjust menu function.
④ CHANNEL +/-	Select the desired channel number.
⑤ VOLUME +/-	Adjust the volume level.
⑥ TV/VIDEO EXIT	Select TV or video terminal input. On the other hand, you can use this button to EXIT from the menu.
⑦ MUTING	Turn off the volume. Press this button again to resume the volume.
⑧ DISPLAY /BACK	Display the program number or video terminal number on the screen. On the other hand, you can use this button to return the previous menu.
⑨ 0~9, 100+	Select the program number. For three digits program number, press 100+, then press the number button.
⑩ RETURN+	a) Return to the frequently view channel with one touch. 1 Choose the channel you want to register. 2 Press and hold RETURN+ button until "RETURN PLUS PROGRAMMED!" appears. To cancel, press and hold RETURN+ button until "RETURN PLUS CANCELED!" appears. b) Return to the previously viewed channel, if you have not set or have canceled the Return channel as above.
⑪ CLOSED CAPTION	Display information in text which are broadcasted by some TV channels.
⑫ FAVORITE CHANNEL CHANNEL (color buttons: red, green, yellow, blue)	Register and recall 4 favorite channels. 1. Choose the TV channel you want to register then press and hold a color button until "FAVORITE CHANNEL ■ PROGRAMMED!" appears. 2. To register other favorite channels, repeat step 1. To recall the favorite channel, press the color button. When the TV is in menu mode, the favorite channel function is not available.

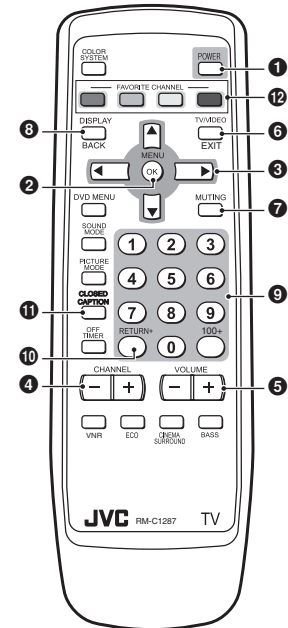

Remote control buttons and basic functions (continued)

How to operate menus and menus locations

To	Operation	Note
Display the MENU	Press the MENU/OK button ②.	To exit the MENU, press the DISPLAY/BACK button ⑧ or choose EXIT menu or TV/VIDEO/EXIT button ⑥.
Display the top menu	Press ▲/▼ buttons ③ to choose a menu title. Then press MENU/OK button ②.	Press ▼ button ③ to display the next page for more functions.
Display the 2nd menu	Press ▲/▼ buttons ③ to choose a menu title. Then press MENU/OK button ②.	
Display the 3rd menu	Press ▲/▼ buttons ③ to choose a menu title. Then press MENU/OK button ②.	
Return to the previous menu	Press the DISPLAY/BACK button ⑧.	—
Choose the setting of a function	Press ▲/▼ buttons ③ to choose a function. Then press the ◀/▶ buttons ③ to change the setting.	Press the TV/VIDEO/EXIT button ⑥ to exit from the menu.
Adjust the effect level of a function	Press ▲/▼ buttons ③ to choose a function. Then press the ◀/▶ buttons ③ to adjust the effect level.	
Display the sub menu of a function.	Press the ▲/▼ buttons ③ to choose a function. Then press MENU/OK button ② to display the sub menu.	—

The following chart shows locations of functions in menus. In this manual, location of a function is described as follows:

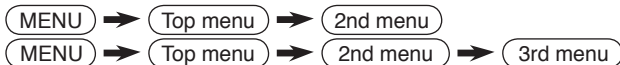

Note: Some functions have the 4th menus as the sub-menus.

MENU	Top menu	2nd menu	Location	3rd menu	Location
MENU	PICTURE	PICTURE MODE	P.9	—	—
		PICTURE SETTING	P.10	PICTURE	P.10
				BRIGHT	P.10
				DETAIL	P.10
	COLOR			P.10	
	TINT	P.10			
	WHITE BALANCE	P.10	—	—	
	VNR	P.15	—	—	
	SOUND	MTS	P.13	—	—
		AI VOLUME	P.13	—	—
		SOUND MODE	P.12	—	—
		EQUALIZER	P.13	—	—
		BALANCE	P.12	—	—
		CINEMA SURROUND	P.13	—	—
	SUPER BASS	P.12	—	—	
	FEATURES	DVD MENU	P.14	AUTO SIGNAL DETECT	P.14
				DVD PICTURE MODE	P.14
				TINT COLOR	P.14
				WHITE BALANCE	P.14
				SOUND MODE	P.14
CINEMA SURROUND				P.14	
OFF TIMER		P.15	—	—	
CHILD LOCK		P.15	—	—	
COMPRESS (16:9)		P.11	—	—	
AI ECO SENSOR		P.11	—	—	
INSTALL	SETUP TOUR	P.16	—	—	
	AUTO PROGRAM	P.17	—	—	
	CHANNEL SUMMARY	P.17	—	—	
	COLOR SYSTEM	P.9	—	—	
	LANGUAGE	P.16	—	—	
	VIDEO-2 SETTING	P.16	—	—	
	BLUE BACK	P.11	—	—	
	CLOSED CAPTION	P.15	CAPTION TEXT	P.15	
PICTURE TILT	P.11	—	—		
EXIT	—	—	—	—	

TV buttons and functions

The illustrations shown below is for 21M, 25M and 29M series only, which are used for explanation purpose.
Your TV may not look exactly the same as illustrated.

Front of the TV

21M / 25M series

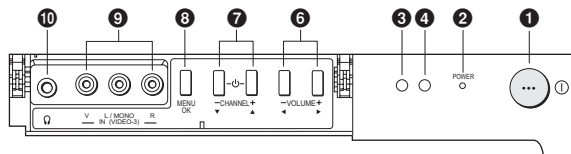

29M series

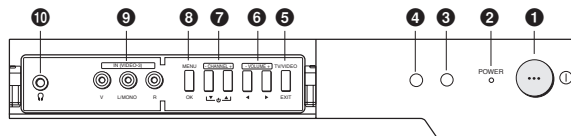

Rear of the TV

21M series

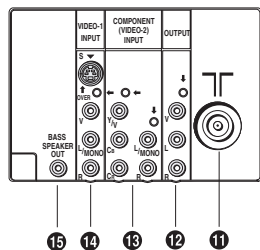

29M series

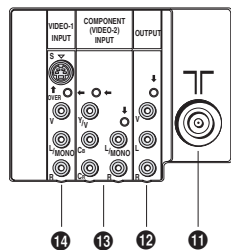

No.	Button/terminal	Description	Page
①	① (main power)	Press to turn on or turn off the TV's main power.	—
②	POWER lamp	Indicate the TV is being turned on or off. No color : TV's main power is being turned off. Red : TV's main power is being turned on. Note: When you turn off the power switch while TV is in standby mode, the light of power lamp will be off in 10 -15 seconds.	—
③	ECO sensor		—
④	Remote control sensor		—
⑤	TV/VIDEO/EXIT	Press to select TV or Video terminal input or exit from menu.	—
⑥	VOLUME +/-	Press to adjust the volume level.	—
⑦	CHANNEL +/-	Press to select the desired channel.	—
⑧	MENU	Press to display the menu.	—
⑨	IN (VIDEO-3)	Video and audio input jacks for VIDEO-3 mode.	18
⑩	Headphone jack.		18
⑪	Aerial socket.		7
⑫	OUTPUT	Video and audio output jacks. (The component video signal cannot be output.)	18
⑬	COMPONENT (VIDEO-2) INPUT	Video or component video, and audio input jacks for VIDEO-2 mode. You can select the input signal by setting the "VIDEO-2 SETTING" function (see page 16).	18
⑭	VIDEO-1 INPUT	Video or S-VIDEO, and audio input jacks for VIDEO-1 mode	7
⑮	BASS SPEAKER OUT	Twin Port Bass Blaster Unit output terminal.	19

How to operate the menus with the TV button

TV button	Work as same as the button on the remote control unit	Note
MENU	MENU/OK button	To display main menu and exit menu after finish setting.
CHANNEL +/-	▼/▲ button	To select menu function.
VOLUME +/-	◀▶ button	To adjust the desired function.

Setting up your TV

CAUTION

- Turn off the equipment including the TV before connecting.

1 Connecting the aerial cable.

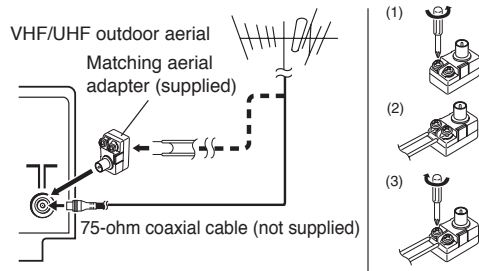

If you connect a VCR, connect the aerial output jack of your VCR and the aerial jack on the TV with aerial cable. Then connect the output jacks of your VCR and the VIDEO-1 input jacks of the TV with the video cable (or S-VIDEO cable if available) and audio cables. For details, see the manual of your VCR.

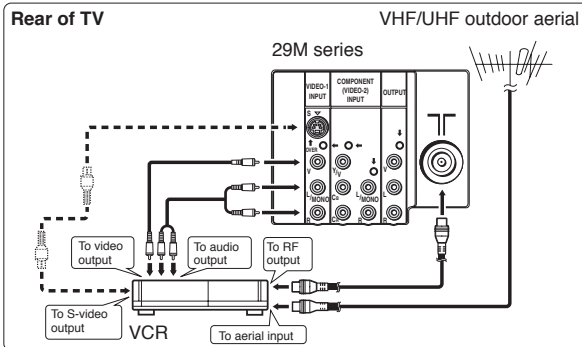

The illustration shown is just a sample. It may not be same as your TV.

2 Connecting the compatible main plug to the AC outlet.

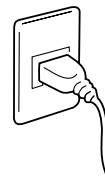

3 Inserting batteries into the remote control.

Insert two batteries by following the ⊕ and ⊖ polarities and inserting the ⊖ end first.

CAUTION:

Follow the cautions printed on the batteries.

Notes:

- Use AA/R6/UM-3 dry cell batteries.
- If the remote control does not work properly, fit new batteries. The supplied batteries are for testing, not regular use.

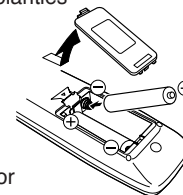

4 Turn on the TV by pressing the main power button.

JVC logo appears on the screen.



JVC logo will appear on the screen again at the phase of "SETUP TOUR RESTART?" function. Then the initial setting can be performed according to page 8.

Setting up your TV (continued)

5 Making the initial settings

Set up your TV by pressing MENU/OK button or waiting for 15 seconds, then operate the TV by following the steps as below:

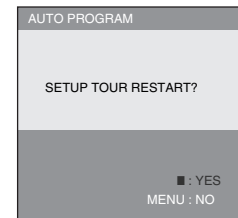
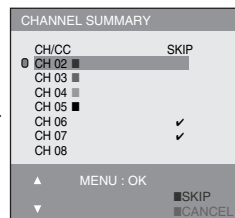
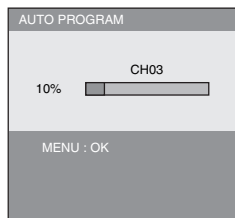
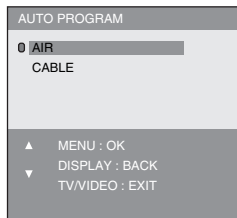
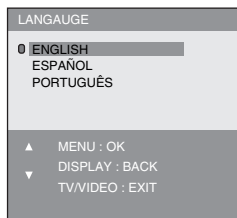

- Press ▲/▼ button to select your desired language.

- Press ▲,▼ button or CH +/- key to select AIR or CABLE, press the MENU/OK button.

- TV will start searching for the channels.

To stop AUTO PROGRAM, press MENU/OK button.

- To complete the initial setting, press the MENU/OK button. To set undesired channels to be skipped, see page 17.

- After that, when turn on the TV at the next time. "SETUP TOUR RESTART?" will be displayed. Press the MENU/OK button to cancel the SETUP TOUR RESTART function. If you want to make initial settings again when the next time you turn on the TV, press the Red button to activate the SETUP TOUR RESTART function.

Basic setting for picture

COLOR SYSTEM

You can select the appropriate color system when the picture is not clear or no color appears.

Press the COLOR SYSTEM button to select a setting.

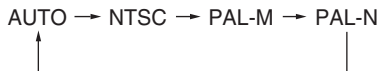

To operate this function with a menu:

* (MENU) ➔ (INSTALL menu) ➔ (COLOR SYSTEM)

For the color system in each country or region, see the table below:

Area	Country or Region	System
South America	Argentina, Paraguay, Uruguay	PAL-N
	Brazil	PAL-M
	Chile, Peru, Bolivia, Colombia, Venezuela, Ecuador, etc.	NTSC

PICTURE MODE

You can choose the desired picture setting with one-touch. Press the PICTURE MODE button to select a setting.

SOFT	Softens contrast and sharpness.
BRIGHT	Heightens contrast and sharpness.
STANDARD	Standard picture setting.
USER	You can change this picture setting as you like. Select USER and adjust following items in the PICTURE SETTING menu. (PICTURE, BRIGHT, DETAIL, COLOR, TINT*)

When you select to VIDEO-2 Mode. You cannot adjust DETAIL and TINT.

*TINT can only be adjusted in NTSC system.

To operate this function with a menu:

* (MENU) ➔ (PICTURE menu) ➔ (PICTURE MODE)

To return the USER setting to the default, press the blue button when the PICTURE SETTING menu appears.

* About the basic operations of the menu, please see the “How to operate menus and menus locations” on page 5.

Basic setting for picture (continued)

PICTURE SETTING

You can adjust the desired picture setting when selecting USER in PICTURE MODE.

- 1 Select the USER in PICTURE MODE under PICTURE menu.

* (MENU) → (PICTURE menu) → (PICTURE MODE)
→ (USER)

- 2 Select the PICTURE SETTING in PICTURE menu, then adjust the setting.

* (MENU) → (PICTURE menu) → (PICTURE SETTING)

PICTURE	◀ : Lower contrast	▶ : Higher contrast
BRIGHT	◀ : Darker	▶ : Brighter
DETAIL	◀ : Softer	▶ : Higher
COLOR	◀ : Lighter	▶ : Deeper
TINT*	◀ : Reddish	▶ : Greenish

When you select to VIDEO-2 Mode. You cannot adjust DETAIL and TINT.

* TINT can only be adjusted in NTSC system.

WHITE BALANCE

You can change the white balance of the picture to better match the type of video being viewed.

Select the WHITE BALANCE in the PICTURE menu, then choose the desired setting.

* (MENU) → (PICTURE menu) → (WHITE BALANCE)

NORMAL	Normal white balance.
COOL	Bluish white.
WARM	Reddish white.

When you select to VIDEO-2. You cannot adjust WHITE BALANCE. You can adjust it in DVD Menu.

* About the basic operations of the menu, please see the “How to operate menus and menu locations” on page 5.

Advanced setting for picture

AI ECO SENSOR (ECO)

You can adjust TV screen contrast according to the brightness of your room.

Press the ECO button to select the desired mode.

OFF	Cancel the function.
MODE-1	Mild contrast (recommended).
MODE-2	Even contrast.
DISPLAY	Display the graphic of the function.

To operate this function with a menu:

* MENU → FEATURES menu → AI ECO SENSOR

Correcting the Slanting Picture (PICTURE TILT)

You can correct the picture tilt caused by the earth's magnetic force.

1 Select the PICTURE TILT in the INSTALL menu, then press MENU/OK button.

* MENU → INSTALL menu → PICTURE TILT

The following display appears.



2 Press the ▲/▼ buttons until the picture become level. Then press the MENU/OK button.

COMPRESS (16:9)

You can convert a normal picture (4:3 aspect ratio) into a wide picture (16:9 aspect ratio).

Select the COMPRESS (16:9) in the FEATURES menu, then choose ON or OFF.

* MENU → FEATURES menu → COMPRESS (16:9)

BLUE BACK

You can set the TV to automatically change to a blue screen and mute the sound if the signal is weak or absent, or when there is no input from an antenna.

Select the BLUE BACK in the INSTALL menu, then choose ON or OFF.

* MENU → INSTALL menu → BLUE BACK

If you wish to continue viewing the poor picture, cancel the BLUE BACK function.

* About the basic operations of the menu, please see the “How to operate menus and menus locations” on page 5.

Basic setting for sound

SOUND MODE

You can choose the desired sound setting.

Select the SOUND MODE in SOUND menu, then choose the setting.

* **MENU** → **SOUND menu** → **SOUND MODE**

USER	You can change this sound setting as you like. Select USER and adjust the frequencies in EQUALIZER (100, 300, 1K, 3K, 8K Hz). For details, see "EQUALIZER" on page 13.
SOUND TURBO	Emphasize on low and high frequency levels.
THEATER	Emphasize on movie sound.
MUSIC	Emphasize on music effect.
NEWS	Emphasize on vocal sound.

When you select to VIDEO-2. You cannot adjust SOUND MODE function. You can adjust it in DVD Menu.

BALANCE

You can adjust the volume balance between the left and right speakers.

Select the BALANCE in SOUND menu, then adjust the setting.

* **MENU** → **SOUND menu** → **BALANCE**

SUPER BASS (BASS)

You can enjoy powerful bass sound with the Twin Port Bass Blaster unit.

Press the BASS button to select ON or OFF.

To operate this function with a menu:

* **MENU** → **SOUND menu** → **SUPER BASS**

For attaching the Twin Port Bass Blaster unit, please see in page 19.

* About the basic operations of the menu, please see the "How to operate menus and menu locations" on page 5.

Advanced setting for sound

CINEMA SURROUND

You can enjoy an enhanced sound for wider audience.
Press the CINEMA SURROUND button to select a setting.

OFF	Cancel the function.
ON	Listen to sound with wider audience effect.

This function is not available when the SOUND MODE is set to SOUND TURBO.

To operate this function with a menu:

* MENU → SOUND menu → CINEMA SURROUND

When you select to VIDEO-2. You cannot adjust CINEMA SURROUND function. You can adjust it in DVD Menu.

MTS

You can enjoy the stereo and SAP broadcasted programs.
Select the MTS in SOUND menu, then choose the desired mode.

* MENU → SOUND menu → MTS

STEREO	Select stereo sound.
SAP	Select second audio programs.
MONO	Select monaural sound.

This function is not available in video mode.

EQUALIZER

You can adjust the sound level of each frequencies when selecting USER mode in SOUND MODE.

1 Select the USER in SOUND MODE under SOUND menu.

* MENU → SOUND menu → SOUND MODE → USER

2 Select the EQUALIZER in SOUND menu.

* MENU → SOUND menu → EQUALIZER

The following display appears.

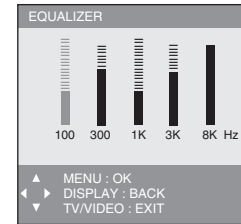

3 Select and adjust the desired frequencies.

4 Press the MENU/OK button to exit the menu.

Adjust high frequency will affect higher pitch sound and vice versa.

AI VOLUME

You can adjust the volume of all the channels and video inputs to the same level automatically depends on the strength of signal of the sources.

Select the AI VOLUME in SOUND menu, then choose ON or OFF.

* MENU → SOUND menu → AI VOLUME

* About the basic operations of the menu, please see the “How to operate menus and menus locations” on page 5.

DVD function

AUTO SIGNAL DETECT

When the DVD input signal is detected. The input mode will be changed to VIDEO-2 automatically.

For the DVD player, press the “POWER ON” button of the machine so that the signal can be detected.

For the VCR, press the “POWER ON” button of the machine, and then press the “PLAY” button, so that the signal can be detected and display DVD menu.

Select the AUTO SIGNAL DETECT in DVD MENU under FEATURES menu then choose ON or OFF (Factory setting is ON).

* (MENU) → (FEATURES menu) → (DVD MENU)
→ (AUTO SIGNAL DETECT)

DVD PICTURE MODE

You can enhance the picture quality of the DVD or VIDEO-2.

Select the DVD PICTURE MODE in DVD MENU under FEATURES menu, then choose the desired setting.

* (MENU) → (FEATURES menu) → (DVD MENU)
→ (DVD PICTURE MODE)

OFF Cancel the function.

CLEAR-1 Select when the disc is with lots of noise (To soften the picture).

CLEAR-2 Select when the disc is with less noise (To sharpen the picture).

TINT COLOR

You can adjust the picture color tone of the DVD.

Select the TINT COLOR in DVD MENU under FEATURES menu, then adjust the level.

* (MENU) → (FEATURES menu) → (DVD MENU)
→ (TINT COLOR)

WHITE BALANCE

You can change the white balance of the DVD picture.

Select the WHITE BALANCE in DVD MENU under FEATURES menu, then choose the desired setting.

* (MENU) → (FEATURES menu) → (DVD MENU)
→ (WHITE BALANCE)

For details, see “WHITE BALANCE” on page 10.

SOUND MODE

You can choose the desired sound setting for the DVD.

Select the SOUND MODE in DVD MENU under FEATURES menu, then choose the desired setting.

* (MENU) → (FEATURES menu) → (DVD MENU)
→ (SOUND MODE)

For details, see “SOUND MODE” on page 12.

CINEMA SURROUND

You can enjoy an enhanced sound for the DVD.

Select the CINEMA SURROUND in DVD MENU under FEATURES menu, then choose the desired setting.

* (MENU) → (FEATURES menu) → (DVD MENU)
→ (CINEMA SURROUND)

For details, see “CINEMA SURROUND” on page 13.

This function is not available when the SOUND MODE is set to SOUND TURBO.

** When you use VIDEO-2 to display the DVD signal or Video signal then WHITE BALANCE, VNR function in PICTURE menu/DETAIL, TINT function in PICTURE SETTING menu/SOUND MODE, CINEMA SURROUND function in SOUND menu cannot operate.

* About the basic operations of the menu, please see the “How to operate menus and menu locations” on page 5.

Customized setting

VNR

You can reduce the picture noise.

Select the VNR in the PICTURE menu, then choose a setting of VNR function.

* **MENU** → **PICTURE menu** → **VNR**

OFF	VNR is turned off.
AUTO	Effect of VNR is automatically controlled.
MIN	Effect of VNR becomes minimum level.
MAX	Effect of VNR becomes maximum level.

If you select MAX, the picture becomes softer even if the original picture is sharp.

When you select to VIDEO-2. You cannot adjust VNR function.

CLOSED CAPTION

If they are included in a program, you can view closed captions or text information.

Press the CLOSED CAPTION button to select a setting.



To operate this function with a menu:

1 Select the CLOSED CAPTION in INSTALL menu, then choose "CAPTION" or "TEXT".

* **MENU** → **INSTALL menu** → **CLOSED CAPTION**

2 Press the ◀▶ button to select the desired caption or text channel.

CHILD LOCK

You can disable the front control buttons of the TV.

Select the CHILD LOCK in the FEATURES menu, then choose ON or OFF.

* **MENU** → **FEATURES menu** → **CHILD LOCK**

OFF TIMER

You can set the TV to turn off automatically to standby mode after a set time.

Press the OFF TIMER button to select a desired period of time.

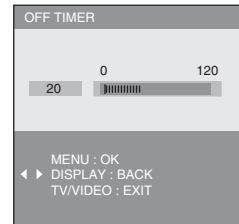

You can set the period of time to a maximum of 120 minutes in 10 minutes step.

To operate this function with a menu:

* **MENU** → **FEATURES menu** → **OFF TIMER**

When the elapsed of time left one minute, "GOOD NIGHT!" appears on the screen.

You can display the OFF TIMER menu again to confirm or change the remaining time.

* About the basic operations of the menu, please see the "How to operate menus and menus locations" on page 5.

Customized setting (continued)

VIDEO-2 SETTING

You can set the VIDEO-2 SETTING according to the video signal output from the external devices connected to the VIDEO-2 terminal.

Select the VIDEO-2 SETTING in INSTALL menu, then choose a setting (Factory setting is COMPONENT).

*  →  → 

VIDEO	If a normal video signal (composite video signal) is input.
-------	---

COMPONENT	If a component video signal (Y/C _B /C _R) is input.
-----------	---

You must choose a setting follow as signal that you input to VIDEO-2. (If you input the VIDEO Signal or VCR Signal to VIDEO-2, you must choose VIDEO-2 SETTING to VIDEO.)

For connecting methods, see “Additional Preparation” on page 18.

DISPLAY



You can display the program number and video terminal number on the screen.

Press the DISPLAY button to display the indication on the screen.

SETUP TOUR

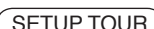

You may use the SETUP TOUR function to perform the initial setting. When selecting SETUP TOUR, the AUTO PROGRAM menu and CHANNEL SUMMARY menu will be displayed as shown on page 8. But “SETUP TOUR RESTART?” will not be displayed.

Select SETUP TOUR in the INSTALL menu.

*  →  → 

LANGUAGE

You can choose your desired on screen display language. Select the LANGUAGE in the INSTALL menu, then choose a language.

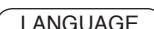
*  →  → 

* About the basic operations of the menu, please see the “How to operate menus and menus locations” on page 5.

TV channel presetting

To register the TV channels automatically (AUTO PROGRAM)

You can register the TV channels into the TV's channel list automatically.

1 Display the INSTALL menu.

* (MENU) → (INSTALL menu)

2 Choose AUTO PROGRAM, then press the MENU/OK button.

3 Press the ▲/▼ button to select AIR or CABLE, then press the MENU/OK button.

AUTO PROGRAM function starts, and the channels received are registered automatically.

4 The CHANNEL SUMMARY menu appears.

For details of "SETUP TOUR", see page 16.

CHANNEL SUMMARY

You can set undesired channels to be skipped.

Channels are to be skipped cannot be selected by the CHANNEL +/- button.

1 Display the INSTALL menu.

* (MENU) → (INSTALL menu)

2 Choose CHANNEL SUMMARY, then press the MENU/OK button. CHANNEL SUMMARY menu appears.

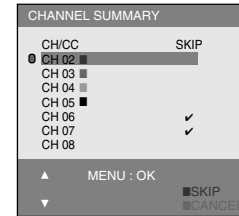

3 Choose the channel which you want to skip.

The skip can be set to all channels of AIR (CH02-CH69) and CABLE (CC01-CC125).

4 Press the yellow button to skip the channel.

To cancel the skip, press the blue button.

5 Press the MENU/OK button to exit the menu.

* About the basic operations of the menu, please see the "How to operate menus and menus locations" on page 5.

Additional preparation

The illustrations shown in this section are for 21M, 25M and 29M series only, which are used for explanation purpose. Your TV may not look exactly the same as illustrated.

Before connecting

- Read the manuals provided with the devices for the proper connection.
- Turn off all the devices including the TV.
- Note that connecting cables are not supplied.

Connecting to front video input terminal

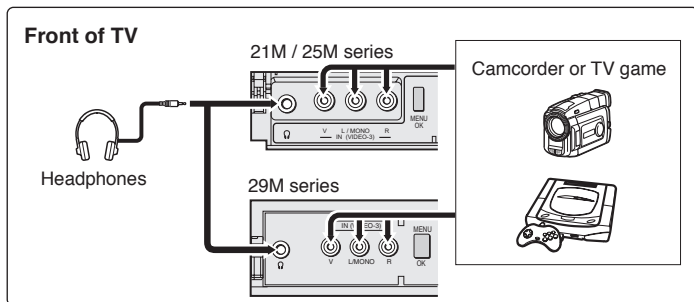

Connecting to rear component/video input terminal and output terminal

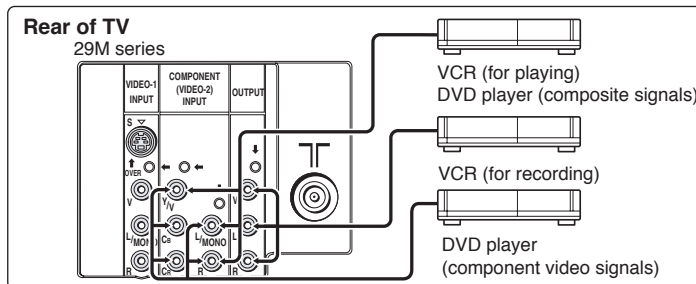
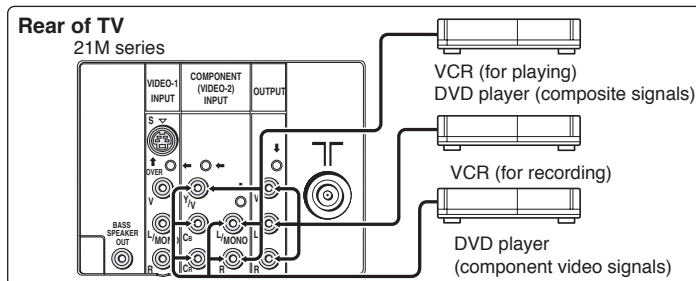

When you use VIDEO-1 INPUT, you should choose to connect S-VIDEO or video input. If S-VIDEO connector and video input are connected at the same time, no picture displays on the screen and the message "PLEASE DISCONNECT VIDEO-1 CABLE!" appears. In this case, you should disconnect either S-VIDEO or video input.

When connecting to COMPONENT (VIDEO-2) input, depending on the connection, choose the appropriate video input using the menu (see page 16).

Additional preparation (continued)

Attaching the Twin Port Bass Blaster Unit

<AV-21MT36/AV-29MT36 only>

The Twin Port Bass Blaster Unit is packaged together with the TV. Before you use the TV, mount the Twin Port Bass Blaster unit correctly on the TV.

- The SUPER BASS (BASS) function do not work unless the Twin Port Bass Blaster Unit is connected correctly to the TV. For details on the SUPER BASS (BASS) function, see page 12.
- 1 Place the unit on top of the TV making sure that the mounting pin on the bottom of the unit fits into the mounting hole on the top of the TV.
 - When you mount the unit, make sure that the mounting pin fits properly into the mounting hole. Otherwise, it may slide off the top of the TV. This may cause damage or cause unexpected injury.

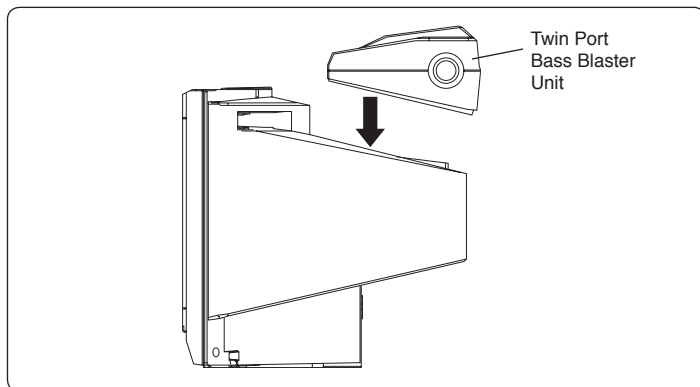

- 2 Firmly insert the Twin Port Bass Blaster Unit connector into the BASS SPEAKER OUT terminal.

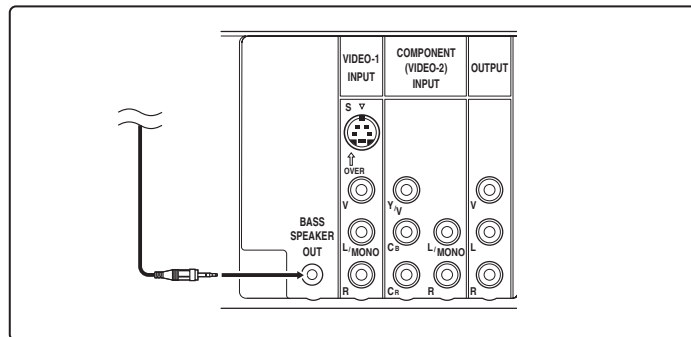

CAUTION:

The Twin Port Bass Blaster Unit is just placed on top of the TV and is not held in place by a screw. When using the unit, pay attention to the following cautions. Otherwise, the unit or TV may fall over and be damaged, or cause unexpected injury.

- Do not rest your hands or elbows on the Twin Port Bass Blaster Unit.
- Do not move the TV with the Twin Port Blaster Unit mounted on top of the TV. Before you move the TV, be sure to remove the unit.
- Do not move the TV by holding the Twin Port Bass Blaster Unit.

Troubleshooting

If a problem occurs when you are using the TV, check the below troubleshooting guide before calling for repair.

• No picture, no sound	• Deactivate the BLUE BACK function if it is turned on.	• Color patches appear at the corner of the screen	• This may be due to the magnetized device such as a speaker near to your TV. Keep the device apart from your TV. Alternately, you can also use the magnetic-shielded speaker.
• Snowy picture	• Check the aerial cable and its connection with the TV.	• Picture is tilted	• This may be due to the earth magnetism. Refer to "PICTURE TILT" on page 11 to correct the tilt.
• Stripes appear on the picture	• Interference occurs caused by other devices such as an amplifier, personal computer, or a hair drier. Move such devices away from your TV.	• Image takes a short period to be displayed	• Image required time to stabilize before display. This is not a malfunction.
• Double-pictures (ghosting) occur	• Interference occurs caused by signal reflecting from mountains or building. Try to adjust the aerial's direction or use a better directionality antenna.	• TV may emitted crackling sound	• This is due to a sudden change in temperature and it is not a malfunction. If the crackling sound is too frequent, request your service technician for inspection.
• Poor picture	• Choose the appropriate color system. Refer to "COLOR SYSTEM" on page 9. • Adjust the COLOR or BRIGHT setting. Refer to "PICTURE SETTING" on page 10.	• Feel a slight electric shock when touching the TV screen	• This is due to the static electricity of the picture tube and it will not harm the human body. This is not a malfunction.
• White and bright still image look as if it were colored	• Inevitable phenomenon due to the nature of the picture tube. This is not a malfunction.	• After you connect the signal to VIDEO-2 and playback VCR or DVD Player, the Auto Detect does not work.	• Please check that the AUTO SIGNAL DETECT function is on or off. • Press button (VCR or DVD Player) to turn the machine off and turn it on again; do not turn the machine off and on suddenly. • Inspect the video cable connection on VIDEO-2 that they are connected properly.
• Top of the image from software products or video tape is distorted	• This is due to the condition of the video signal whereby the image was not recorded properly. This is not a malfunction.	• When you are watching another channel that is not VIDEO-2, AUTO SIGNAL DETECT works while VCR or DVD Player was on.	• Inspect the video cable connection on VIDEO-2 that they are connected properly. • In a certain VCR or DVD Player, the function might operate by the discontinuity of the signal.
• Poor sound	• Adjust the sound frequency properly. Refer to "EQUALIZER" on page 13.	• While you are watching TV on the other channels, AUTO SIGNAL DETECT works when you press ◀◀, ■, ▶▶, or on the front panel of VCR or DVD Player.	• In a certain VCR or DVD Player, the function might operate by the discontinuity of the signal.
• Stereo or SAP sound is unclear	• TV channel reception is poor. Change the stereo/SAP mode to mono sound (see page 13).	• Cannot operate the remote control	
• Cannot operate the remote control	• The batteries may be exhausted. Replace with new batteries (see page 7). • Ensure that you are operating the remote less than seven meters from the front of your TV.	• Cannot operate the menus	
• Cannot operate the menus	• Press TV/VIDEO button to return to TV mode and try operating the menus.	• Cannot operate the front control buttons	
• Cannot operate the front control buttons	• Deactivate the CHILD LOCK function if it is turned on (see page 15).	• After TV was on, AUTO SIGNAL DETECT works.	• Video signal from VCR or DVD Player cause the function runs properly to indicate that there are video signal on VIDEO-2 channel.

Specifications

TV RF systems

M, N

Color systems

NTSC, PAL-M, PAL-N

Receiving channels

VHF low channel (VL), VHF high channel (VH), UHF channel (U)

Receives cable channels in mid band, super band and hyper band.

Power requirements

AC 110 to 240 V, 50 Hz / 60 Hz

External input / output

VIDEO-1: S-video input, VIDEO input, AUDIO L/R input

VIDEO-2/COMPONENT: VIDEO input, AUDIO L/R input, COMPONENT VIDEO (Y/C_b/C_r) input

VIDEO-3: VIDEO input, AUDIO L/R input

OUTPUT: VIDEO output, AUDIO L/R output

Headphone jack: Stereo mini jack (3.5 mm diameter)

Sound-multiplex systems

MTS (Multi-channel Television Sound)

Design and specifications subject to change without notice.

JVC